

**5** We recommend removing insulation sitting directly on top of the luminaire to ensure optimal performance. However, this is not mandatory as the luminaire meets or exceeds the requirements for IC-4 when covered. Do not cover the driver.

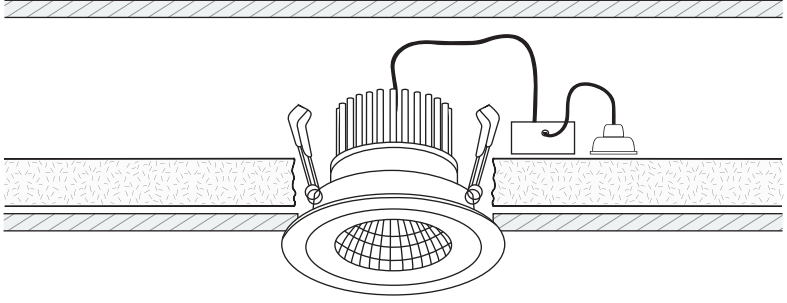

**6** Restore power once installation has been completed.

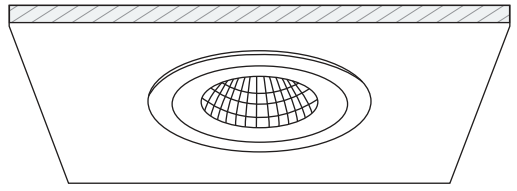

V1-01.04.2023 Product designs and technical data may be subject to change

# Resiled RDC8 Recessed Downlight *Installation Guide*

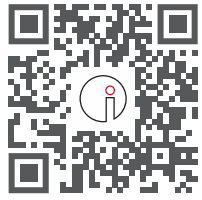
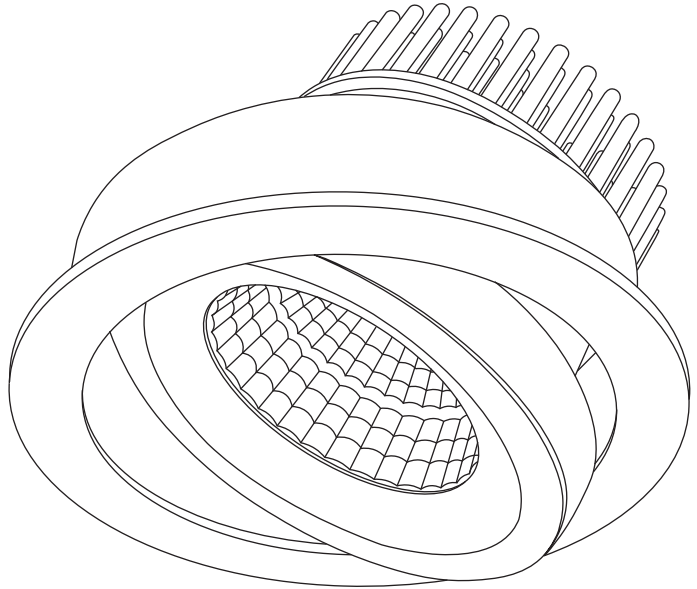

Resiled RDC8

**For warranty information, please visit**

[trendlighting.com.au/warranty](http://trendlighting.com.au/warranty)

**Important Safety Information**

Please read these installation instructions carefully before installing this luminaire.

- This product must be installed by a licensed electrician in accordance with AS/NZS 3000 and local regulations.
- Isolate the mains power supply prior to installation.
- Only reconnect mains power after installation is completed.
- No part of the luminaire should be altered or modified.
- This product is not user serviceable.

**Approvals**

The Resiled range is IC-4 rated and can be installed in locations where it is covered or abutted with thermally insulating material in accordance with AS/NZS 60598.2.2:2016.

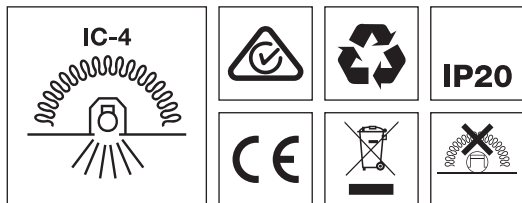

The RCM marking of this product applies to AS/NZS 4417.1 "Regulatory compliance mark (RCM) for electrical and electronic equipment". This product is designed to conform to AS/NZS 60598 "Luminaires, general requirements and tests".

- 1** Isolate the mains power supply prior to commencing installation.

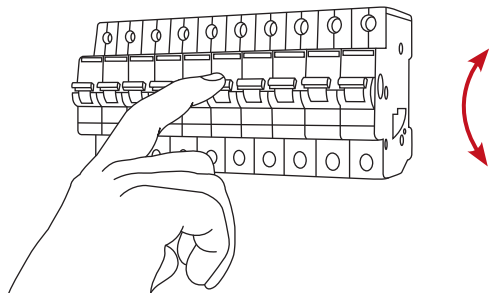

- 2** Mark at the correct location. Cut a hole in the ceiling in accordance with cutout size. RDC8 ceiling cutout: **92 mm**

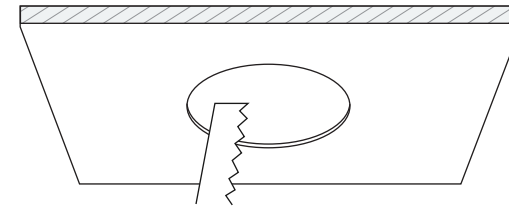

- 3** Connect luminaire to 240V plug socket.

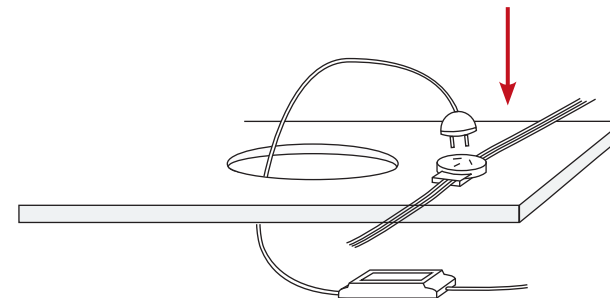

- 4** Lift the springs upward to ensure the luminaire can be installed into the mounting hole.

