

- 5** Connect / Reconnect track to power and switch the track selection knob to the required circuit (Circuit 1 shown below).

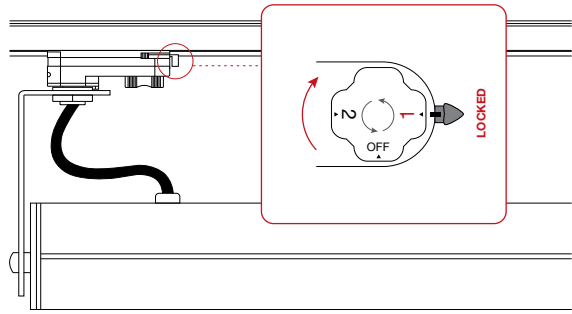

- 6** To change the tilt angle, adjust the luminaire's body to the desired angle.

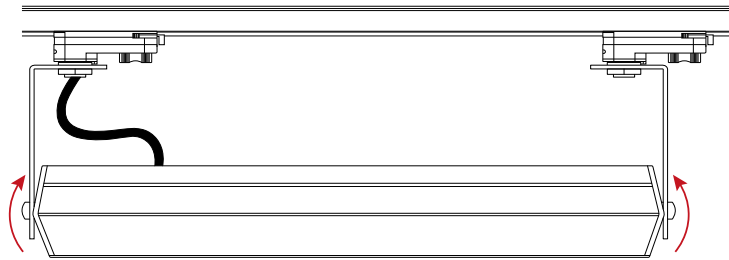

Track Linear XTLX600

Installation Guide

V1-07.05.2024 Product designs and technical data may be subject to change.

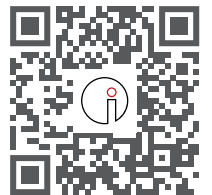
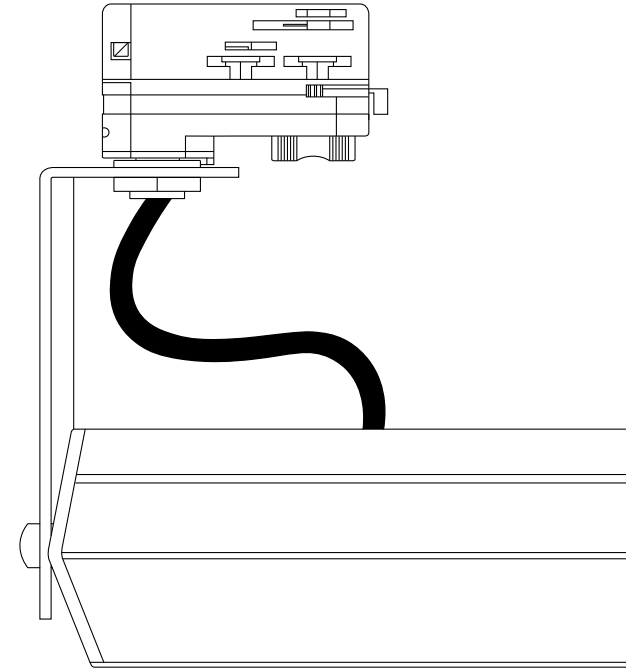

For warranty information, please visit
trendlighting.com.au/warranty

Important Safety Information

Please read these installation instructions carefully before installing this luminaire.

- This product must be installed by a licensed electrician in accordance with AS/NZS 3000 and local regulations.
- Isolate the mains power supply prior to installation.
- Only reconnect mains power after installation is completed.
- No part of the luminaire should be altered or modified.
- This product is not user serviceable.

Installation Notes



Product Code

XTLX600

Dimensions (LxWxH)

590 x 40 x 120 mm

- 1** Isolate the mains power supply prior to commencing installation.

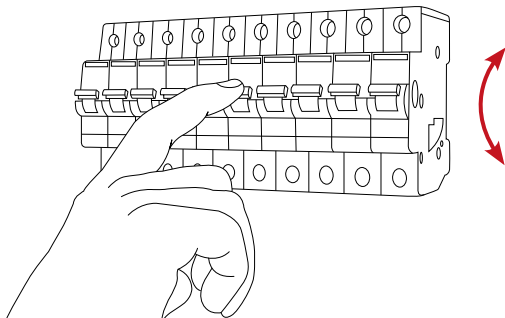

- 2** Check to ensure the circuit selector knob is set to 'off' and the locking lever is in the 'released' position.

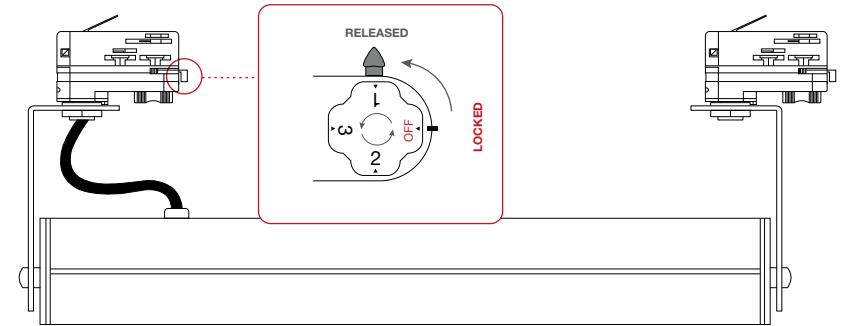

- 3** Ensure the track connector is oriented correctly in the track.

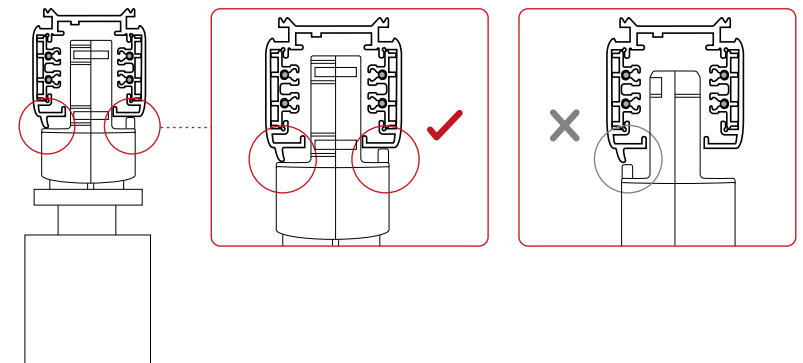

- 4** Insert luminaire into the track and move locking lever to the locked position.

