



Scan to explore
ZTX60 online

Track Linear ZTX60

60W Continuous Linear Track

Product Code	Colour Temperature	Colour Technology	Beam Angle	Trim Colour	Driver
ZTX60	3 (3000K)	(CRI 90+ Standard)	VW (Very Wide)	W (White)	DALI (DALI)
	4 (4000K)			B (Black)	ND (Non-dimmable)

Order Code **ZTX604-VW-B-ND**



Product Features

- Track mounted linear system with high efficacy and light performance
- High efficiency acrylic lens design provides smooth light distribution in symmetrical or asymmetrical beam options
- CRI 90+ available in 3000K and 4000K CCT options
- Supplied with universal 3 circuit track adapter for quick and easy installation on a variety of track systems
- Supplied with integral driver

Product Attributes



To configure this track light please visit
trendlighting.com.au/product/track-linear-ZTX60

Physical Characteristics

Trim Colour	White Black
Dimensions (LxWxH)	1153 x 80 x 85 mm
Weight	2218 g

Dimensions (mm)

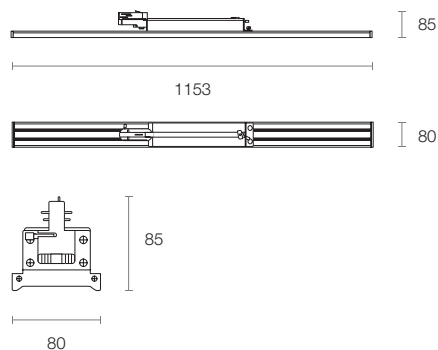

Technical Characteristics

Based on ZTX604-VW-B-ND

LED Power	60W
LED Type	SMD
Lumen Output	8100 lm
Luminous Flux	6600 lm
Efficacy	106.45 lm/W
Colour Temperature	3000K 4000K
Colour Technology	CRI 90+
Colour Deviation	SDCM ≤ 3
Lifetime	50,000 hours (L80)
Beam Angle	Very Wide
System Power	62W Typical
Driver Model	Trend DR-ZTX60 (Non-dim)
Input	200-240V AC 50/60 Hz
Power Factor	>0.95
Protection	OVP, OTP, OCP, SCP, OPP
Dimming	Non-dimmable DALI

General Characteristics

Category	Track Systems (Track Light)
Family	Track Linear
Surface	Ceiling
Mounting	Track Mounted
Ingress Protection	IP20



Scan to explore
ZTX60 online

Track Linear ZTX60

60W Continuous Linear Track

Product Code	Colour Temperature	Colour Technology	Beam Angle	Trim Colour	Driver
ZTX60	3 (3000K)	(CRI 90+ Standard)	VW (Very Wide)	W (White)	DALI (DALI)
	4 (4000K)			B (Black)	ND (Non-dimmable)

Order Code **ZTX604-VW-B-ND**

To configure this track light please visit
trendlighting.com.au/product/track-linear-ZTX60

Trim Colour

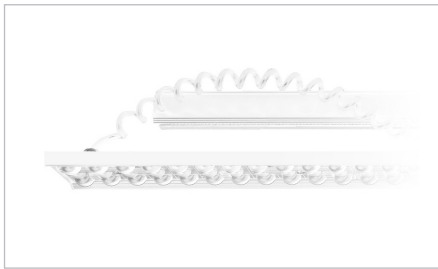

W
White Trim

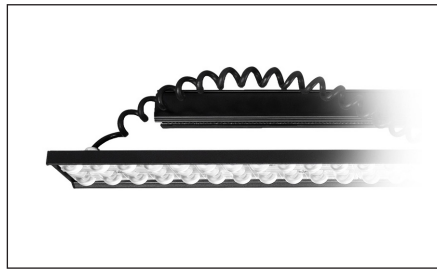

B
Black Trim

Compatible 3 Circuit Track Systems

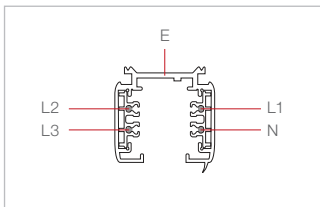

TRA3C
3 Circuit Track
Dimensions 33 x 35 mm
Max. Continuous Length 3000 mm
Track Colour White | Black | Silver

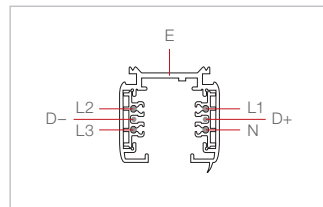

TRA3C-DALI
3 Circuit DALI Track
Dimensions 33 x 35 mm
Max. Continuous Length 3000 mm
Track Colour White | Black | Silver

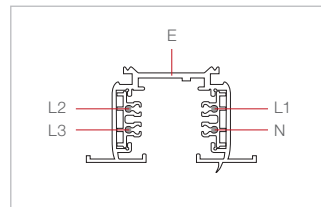

TRA3CR
3 Circuit Recessed Track
Dimensions 56.2 x 35 mm
Max. Continuous Length 3000 mm
Track Colour White | Black | Silver

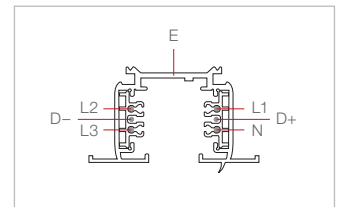

TRA3CR-DALI
3 Circuit Recessed DALI Track
Dimensions 56.2 x 35 mm
Max. Continuous Length 3000 mm
Track Colour White | Black | Silver