



Scan to explore
XTN10E online

Track Spot XTN10E

10W Sleek Track Spot

Product Code	Colour Temperature	Colour Technology	Beam Angle	Trim Colour	Accessories *	Driver
XTN10E	2.7 (2700K)	(CRI 94+ Standard)	NB (Narrow)	W (White)	HL (Honeycomb Lens)	ND (Non-dimmable)
	3 (3000K)	S (CRI 98+ Optisolis)	MB (Medium)	B (Black)		DALI (DALI)
	3.5 (3500K)		WB (Wide)			
	4 (4000K)					

Order Code **XTN10E4-WB-B-ND**

* Optional accessories



Product Features

- Track mounted sleek LED spotlight known for its high colour rendering and excellent glare control
- Ceramic Nichia LED chip with a high efficiency collimating lens
- Can be configured with Nichia's award winning Optisolis™ LED
- CRI 94+ and CRI 98+ Optisolis available in 2700K, 3000K, 3500K and 4000K CCT options
- Supplied with a 3-circuit track adapter and integral track mounted driver
- Optional honeycomb lens available

Product Attributes



To configure this track light please visit

trendlighting.com.au/product/track-spot-XTN10E

Physical Characteristics

Trim Colour	White Black
Tilt Angle	90°
Rotation	350°
Dimensions	Ø62 x 185 (H) mm
Weight	685 g

Dimensions (mm)

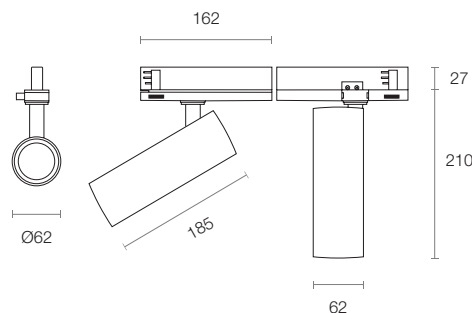

Technical Characteristics

Based on XTN10E4-WB-B-ND

LED Power	10W
LED Type	COB
Lumen Output	1350 lm
Luminous Flux	1010 lm
Efficacy	84.87 lm/W
Colour Temperature	2700K 3000K 3500K 4000K
Colour Technology	CRI 94+ CRI 98+ Optisolis
Colour Deviation	SDCM ≤ 3
Lifetime	60,000 hours (L80 B10)
Beam Angle	Narrow Medium Wide

System Power	11.9W Typical
Driver Model	Trend 150423-250 (Non-dim)
Input	220-240V AC 50/60 Hz
Output	25-42V DC 250mA
Power Factor	>0.98
Protection	OVP, OTP, OCP, SCP, OPP
Dimming	Non-dimmable DALI

General Characteristics

Category	Track Systems (Track Light)
Family	Track Spot
Surface	Ceiling
Mounting	Track Mounted
Ingress Protection	IP20



Scan to explore
XTN10E online

Track Spot XTN10E

10W Sleek Track Spot

Product Code	Colour Temperature	Colour Technology	Beam Angle	Trim Colour	Accessories *	Driver
XTN10E	2.7 (2700K)	(CRI 94+ Standard)	NB (Narrow)	W (White)	HL (Honeycomb Lens)	ND (Non-dimmable)
	3 (3000K)	S (CRI 98+ Optisolis)	MB (Medium)	B (Black)		DALI (DALI)
	3.5 (3500K)		WB (Wide)			
	4 (4000K)					

Order Code **XTN10E4-WB-B-ND**

* Optional accessories

To configure this track light please visit
trendlighting.com.au/product/track-spot-XTN10E

Trim Colour



W
White Trim



B
Black Trim

Accessories *



HL
Honeycomb Lens

Compatible 3 Circuit Track Systems

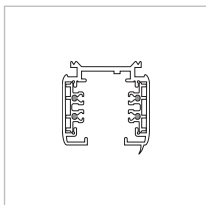

TRA3C
3 Circuit Track
Dimensions 33 x 35 mm
Max. Length 3000 mm
White | Black | Silver

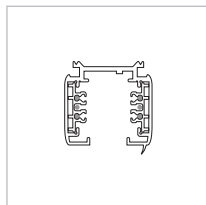

TRA3C-DALI
3 Circuit DALI Track
Dimensions 33 x 35 mm
Max. Length 3000 mm
White | Black | Silver

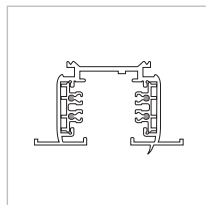

TRA3CR
3 Circuit Recessed Track
Dimensions 56.2 x 35 mm
Max. Length 3000 mm
White | Black | Silver

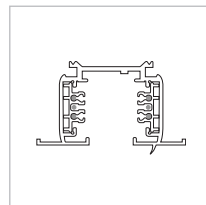

TRA3CR-DALI
3 Circuit Recessed DALI Track
Dimensions 56.2 x 35 mm
Max. Length 3000 mm
White | Black | Silver

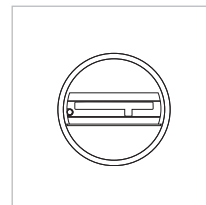

TRA3C-SA
3 Circuit Surface Mounted Monopoint
Dimensions Ø110 x 35 mm
White | Black

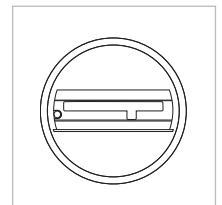

TRA3C-DALI-SA
3 Circuit Surface Mounted DALI Monopoint
Dimensions Ø143 x 35 mm
White | Black