

V2-20.07.2023 Product designs and technical data may be subject to change

Multiled DTL12 Recessed Tricolour LED Downlight

Installation Guide

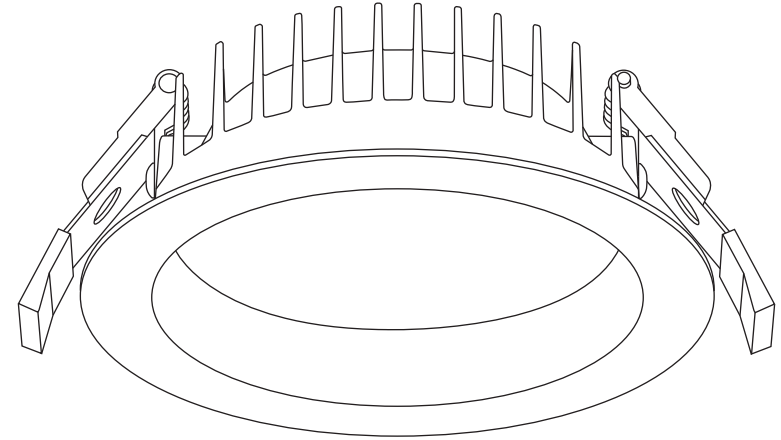

Scan to explore
DTL12 online

For warranty information, please visit
trendlighting.com.au/warranty

Important Safety Information

Please read these installation instructions carefully before installing this luminaire.

- This product must be installed by a licensed electrician in accordance with AS/NZS 3000 and local regulations.
- Isolate the mains power supply prior to installation.
- Only adjust the CCT switch when luminaire is powered off.
- Only reconnect mains power after installation is completed.
- No part of the luminaire should be altered or modified.
- This product is not user serviceable.

Installation Notes

The Multiled range is IC-4 rated and can be installed in locations where it is covered or abutted with thermally insulating material in accordance with AS/NZS 60598.2.2:2016.

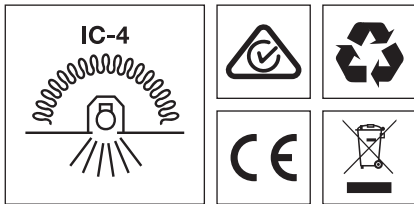

- 1** Isolate the mains power supply prior to commencing installation. Only adjust the CCT switch when luminaire is powered off. CCT switch illustration is shown below.

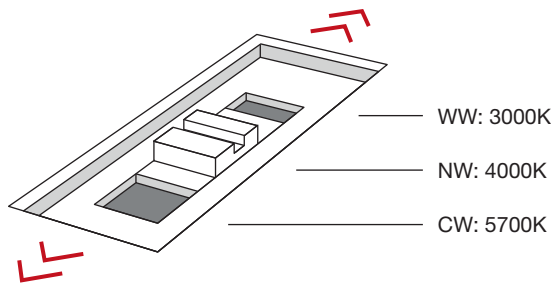

- 2** Ceiling cutout: **DTL12**: 120-130 mm

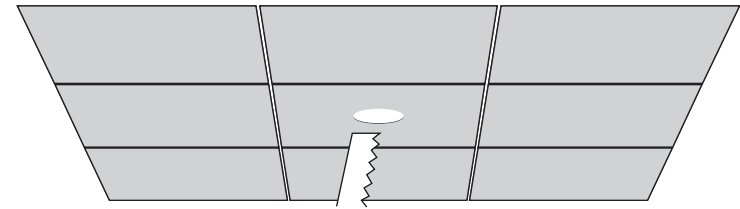

- 3** Connect luminaire to 240V plug socket.

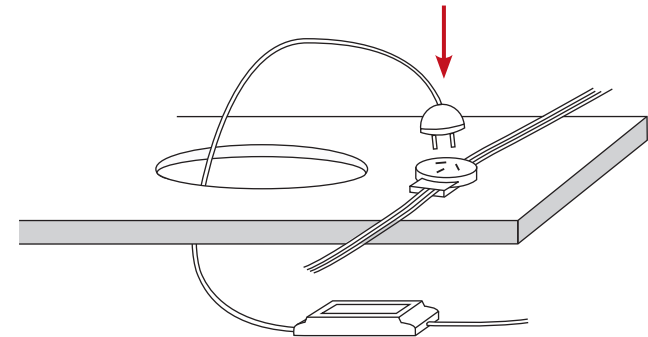

- 4** Please ensure LED driver **(A)** is fixed above any insulation **(B)**. Push springs upward and install luminaire into ceiling **(C)**. Restore power once installation has been completed.

